

UAE EQUESTRIAN & RACING FEDERATION



GENERAL RULES

NATIONAL DRESSAGE COMPETITIONS

These Rules are effective from 01 January 2023

and

replace all previously issued Rules,

Regulations and Instructions.

CONTENTS

	Page
Contents List	2-5
Mission Statement	6
SECTION I- INTRODUCTION AND DEFINITIONS	
Article 100. General Regulations	7
Article 101. Rules	7
Article 102. Application of Rules	7
Article 103. Financial Responsibility	7
Article 104. Definitions	7-8
SECTION II- GENERAL RULES	8
CHAPTER I – CODE OF CONDUCT	
Article 105. Code of Conduct for the Welfare of the Horse	8-9
Article 106. Code of Conduct for good sportsmanship	9
CHAPTER II – DRESSAGE	
Article 107. Object and general principles of dressage	10
CHAPTER III – COMPETITIONS	
Article 108. Recognition	11
Article 109. Competition	11
Article 109.1 Senior Levels and Competitions	11-12
Article 109.2 Junior Levels and Competitions	13
Article 110. Levels of Competitions	14
Article 111. Tests	14
Article 112. Execution of the Test	14-18
Article 113. Time and Technical Failure	18
Article 114. Judges' Sheets	19
Article 115. Results and Calculations of Scores	19-21
Article 116. Entries	21
Article 117. Schedules	22
Article 118. Organisers	22
Article 119. Arenas and Exercise Arenas	22-23
Article 120 Medical and Veterinary Services	24
Article 121. Starting Possibilities	24
Article 122. Identification	24
Article 123. Hors Concours	24
Article 124. Callers	24
Article 125. Warm-up	25

Article 126. Unforeseen Circumstances	25
CHAPTER 1V – UAE-ERF NATIONAL CHAMPIONSHIPS	
Article 127. Place & Date	25
Article 128. Starting possibilities	26
Article 129. Numbers to Qualify	26
Article 130. Competitions in the National Championship	26
CHAPTER V – FEI WORLD DRESSAGE CHALLENGE (WDC) SELECTION/QUALIFYING RULES	27
CHAPTER VI – CEREMONIES, PRIZES AND EXPENSES	
Article 131. Ceremonies	27
Article 132. Prizes	27-29
Article 133. Expenses	29
CHAPTER VII – RIDERS	
Article 134. General	29
Article 135. Registration – Riders	29
Article 136. Person Responsible	29-30
CHAPTER VIII – HORSES	
Article 137. Eligibility	30
Article 138. Registration – Horses	30
Article 139. Horses name	30
Article 140. Horses age	30-31
Article 141. Competitive condition	31
CHAPTER IX – DRESS	
Article 142. Dress Code- General	31
Article 143. Advertising	31
Article 144. Jacket/Coat	31
Article 145. Hats	32
Article 146. Breeches/Jodhpurs	32
Article 147. Gloves	32
Article 148. Boots	32
Article 149. Spurs	32
Article 150. Whips	33
Article 151. Earphones	33
CHAPTER X – SADDLERY	
Article 152. Saddles	33
Article 153. Saddle Clothes	33
Article 154. Logos	34
Article 155. Bridles and bits	34
Article 156. Gadgets	34
Article 157. Decorations	34

Article 158. False Tail/Tail Extensions	34-35
Article 159. Protective fly hoods	35
Article 160. Checking of Saddlery	35
Article 161. Saddlery and bits in the warming-up and training arenas	35
CHAPTER XI - GRADING SYSTEM	
Article 162. Grading Points	36
Article 163. Grading/Upgrading Horses	36
Article 164. Downgrading of Horses	36
Article 165. Grading on Imported Horses	37
Article 166. Grading of Riders	37
CHAPTER XII – SAFETY	
Article 167. Horse out of control	37
Article 168. Disobedience	37-38
Article 169. Dangerous situations	38
CHAPTER XIII - PROTECTION OF ATHLETES AND HORSES	
Article 170. Protection of Athletes	38
Article 171. Protection of Horses	38
Article 172. Abuse of Horses	38-39
Article 173. Medication Control and Anti-Doping	39
Article 174. Veterinary Examination	39
CHAPTER XIV - JUDGES AND OFFICIALS	
Article 175. Mission	40
Article 176. Conflict of Interest	40
Article 177. Reports	40
Article 178. A Federation Officials Code of Conduct	40
Article 179. B Federation Officials Code of Conduct	40-41
Article 180. Judges	41
Article 181. Official Representative at an Event	41
Article 182. Senior Judge/ Ground Jury Duties	41-42
Article 183. Stewards	42-43
CHAPTER XV - THE LEGAL SYSTEM	
Article 184. Preamble	43
Article 185. Federation Powers	44
Article 186. Penalties	44-45
CHAPTER – XIV – OBJECTIONS	
Article 187. Submission of Objections	45-46
Article 188. Time Limit	46
Article 189. Referral to Federation	46
Article 190. Query	46
Article 191. Appeal	46

Appendix 1. Permitted Bridles and Bits
Appendix 2. Arena Sizes

47-49
50-51

MISSION

The Mission of
The United Arab Emirates Equestrian & Racing Federation
With this Rule Book
is
to Promote, Guide, Develop and Manage Equestrianism
in
The United Arab Emirates
and to do so in a Manner
which Promotes the Highest Standards in both
Equestrianism and Animal Welfare

SECTION 1 - INTRODUCTION AND DEFINITIONS

Article 100. General Regulations:

1. These Rules are established so that competitors and teams of competitors may compete against each other under fair and equal conditions.
2. They can, however, never cover every eventuality. Matters which cannot be resolved by interpreting the rules to the letter, shall be resolved in the spirit of the Rules to obtain a solution, which fairly represents the ethics, integrity and spirit of the sport.
3. Recourse to **FEI** Rules is permitted when appropriate and not covered by **NF** Rules and authorized by **UAEERF**
4. It is the absolute, sole and personal responsibility of all Officials and persons registered with the Federation to be fully familiar with all published Rules, Regulations and Instructions of the Federation, as ignorance of any such Rules, Regulations or Instructions will never be accepted as a valid excuse for, nor as mitigation for, transgressions which may occur.
5. **NF** will publish rules online as well as periodic updates.
6. It is the sole responsibility of the rider to ensure that they are au fait with the rules.
7. **NF** to set up email alias to receive and respond to any questions the riders may have.

Article 101. Rules:

These Rules have been drawn up in the broadest possible spirit to allow Organizers of events as much freedom as possible in the preparation and management of their programs.

Article 102. Application of Rules:

1. The Dressage Rules of The United Arab Emirates Equestrian and Racing Federation (**NF**) shall apply to all events held under the auspices of **NF**, rather than International Events, which must be held under the Rules of the Federation Equestre International (**FEI**).
2. Local amendments to dressage rules to be reviewed by a Dressage Rules Committee prior to implementation.

Article 103. Financial Responsibility:

The UAEERF accepts no financial responsibility whatsoever for events held under its auspices or under its rules.

Article 104. Definitions:

Terms used in these Rules are defined as follows:

1. **Agent:** An employee of, or other person, who is duly authorized by, an Owner or person registered with NF, to be their person responsible areas.
2. **Competition:** The term “competition” refers to each individual class for which placings and prizes are awarded.
3. **Discipline:** The term “discipline” refers to the type of event or competition which can be either Dressage, Show Jumping, Eventing, Combined Event, or any other which the Federation may decide.
4. **Event:** The term “event” refers to the complete meeting, show or concours under the control of the Organizers'. “Events” may include “competitions” for more than one “discipline”
5. **The Federation:** The United Arab Emirates Equestrian and Racing Federation or NF or The Dressage Committee of UAEERF.
6. **Guardian:** A person, duly authorized to act on behalf of the person legally responsible for the underage individual.
7. **Height:** Pony height is up to and including 148cms. Horse height exceeds 148cms.
8. **Horse:** Refers also to a Pony or other member of the genus Equus unless the context requires otherwise. A Horse shall be born from a mare.
9. **Junior:** A person may compete as a Junior from the beginning of the calendar season in which he/she reaches the age of Sixteen (16) until the end of the same season i.e if 16 when registering with the UAEERF at the beginning of the season Oct-April of any given year the person may ride as a junior throughout that same season.
10. **Senior:** A person may compete as a Senior when he/she reaches the age of Seventeen (17).
11. **Judge:** A member of the Judges’ panel appointed by the Federation or be appointed by the Event Organizing Committee.
12. **Organizers:** The organizer or organizing committee (OC) recognized by NF and responsible for organizing any equestrian event. Criteria against which NF will recognize the OC should be published prior to commencement of the competition season.
13. **Person Responsible:** In all cases the rider is deemed to be the Person Responsible (P.R.)
14. **Registered Person:** Any paid-up person for the year current with The United Arab Emirates Equestrian and Racing Federation.
15. **Rules:** The Rules of The United Arab Emirates Equestrian and Racing Federation.
16. **Show Ground:** The area in which the ring/arena, collecting ring, exercise/assembly areas, transport parks and stabling are situated.
17. **Trainer:** A person whose normal employment/appointment in the UAE is that of Dressage Trainer or a person officially appointed by NF to act as Official Trainer.
18. **Year:** The year commences on 1st January and ends on the 31st December, as per FEI.
19. **UAE competition season:** from October 1st to June 1st.

SECTION II - GENERAL RULES

CHAPTER I CODE OF CONDUCT

Article 105. Code of Conduct for the Welfare of the Horse:

1. In all equestrian disciplines the horse must be considered paramount.
2. The wellbeing of the horse shall be above all demands of breeders, trainers, owners, riders, dealers, organizers, officials or any agent of such persons.
3. All handling and veterinary treatment must ensure the health and welfare of the horse.
4. The highest standards of nutrition, health sanitation and safety shall be encouraged and maintained at all times.
5. Adequate provision must be made for ventilation, feeding, watering and maintaining a healthy environment during transportation.
6. Emphasis should be placed on increasing education in training and equestrian practices and on promoting scientific studies in equine health.
7. In the interest of the horse, the fitness and competence of the rider, his groom or any other agent, shall be regarded as essential.
8. All riding and training methods must take account of the horse as a living entity and must not include any equipment or technique considered by **NF** or the **F.E.I.** to be abusive.
9. The UAEERF hereby establishes a control in order that all persons under its jurisdiction, their agents or guardians respect the welfare of the horse.
10. The National and International Rules and Regulations in equestrian sport regarding health and welfare of the horse must be adhered to not only during National and International competitions but also in training.
11. Compliance with this code of Conduct is a pre-requisite of all persons registered with UAEERF, and their agents or guardians.

Article 106. Code of Conduct for Good Sportsmanship:

No Official, Owner, Rider, Trainer, Agent or Guardian at an event shall:

1. Argue with a Judge or Official or use abusive, threatening or unseemly language or behave with incivility or contempt towards a Judge or Show Official.
2. Conduct him/herself in a manner which is offensive to the public or detrimental to the character or prejudicial to the interests of **NF**.
3. Ill-treat a horse in any way whether inside or outside the arena.
4. Make remarks orally, in writing or on social media, about an officer of **NF**, the Jury, Judges or the Organizer, a statement on any matter covered by the Rules, which he knows to be untrue or slanderous.
5. Compete as owner or rider in a competition for which the horse or rider are not fully eligible.
6. Having started a competition, then willfully incur elimination.
7. Unreasonably refuse to assist **NF** at any inquiry.
8. Offend in any way the Codes of Conduct as published in this Rule Book.
9. Behave in a manner which brings the Country, the Sport or **NF** into disrepute.
10. Any person who commits a breach of any part of this rule shall be deemed to be guilty of unseemly conduct and in respect of a breach of Article 106. Code of Conduct. They shall be eliminated from the competition by the Ground Jury or Senior Judge and/or referred to **NF**.

CHAPTER II DRESSAGE

Article 107. Object and General Principles of Dressage

1. The object of Dressage is the development of the Horse into a happy Athlete through harmonious education. As a result, it makes the Horse calm, supple, loose and flexible, but also confident, attentive and keen, thus achieving perfect understanding with the Athlete. These qualities are demonstrated by:
 2. The freedom and regularity of the paces.
 3. The harmony, lightness, and ease of the movements.
 4. The lightness of the forehand and the engagement of the hindquarters, originating from a lively impulsion.
 5. The acceptance of the bit, with submissiveness/thoroughness without any tension or resistance.
 6. The Horse thus gives the impression of doing, of its own accord, what is required. Confident and attentive, submitting generously to the control of the Athlete, remaining straight in any movement on a straight line and bending accordingly when moving on curved lines.
 7. The walk is regular, free and unconstrained. The trot is free, supple, regular and active. The canter is united, light and balanced. The hindquarters are never inactive or sluggish. The Horse responds to the slightest indication of the Athlete and thereby gives life and spirit to all the rest of its body.
 8. By virtue of a lively impulsion and the suppleness of the joints, free from the paralyzing effects of resistance, the Horse obeys willingly and without hesitation and responds to the various aids calmly and with precision, displaying a natural and harmonious balance both physically and mentally.
 9. In all the work, even at the halt, the Horse must be “on the bit”. A Horse is said to be “on the bit” when the neck is more or less raised and arched according to the stage of training and the extension or collection of the pace, accepting the bridle with a light and consistent soft submissive contact. The head should remain in a steady position, as a rule slightly in front of the vertical, with a supple poll as the highest point of the neck, and no resistance should be offered to the Athlete.
 10. Cadence is shown in trot and canter and is the result of the proper harmony that a Horse shows when it moves with well-marked regularity, impulsion and balance. Cadence must be maintained in all the different trot or canter exercises and in all the variations of these paces.
 11. The regularity of the paces is fundamental to Dressage.

CHAPTER III COMPETITIONS

Article 108. Recognition:

No competition shall be recognized by NF unless judged under NF Rules, or in the case of International Competitions, under the Rules of the F.E.I.

Article 109. Competition:

- The term “competition” refers to each individual class for which placings and prizes are awarded
- Separate Competitions for the following standard categories of Athletes may be included in the schedules for all Events unless stated otherwise in the Rules:

109.1 SENIOR LEVELS AND COMPETITIONS

Athlete's Age	Levels of Competition	Double / Snaffle	Horse Age	NF Tests	FEI Tests
Min. 16 yo	Introduction	Snaffle	Min 4 yo	-Intro 1 2023 -Intro 2 2023 -Intro 3 2023 -Intro 4 2023 -Intro 5 2023 -Intro 6 2023	
Min 16 yo	Preliminary	Snaffle	Min 4 yo	-Prelim 1 2023 -Prelim 2 2023 -Prelim 3 2023 -Prelim 4 2023 -Prelim 5 2023 -Prelim 6 2023	
Min 16 yo	Novice	Snaffle	Min 5 yo	-Novice 1 2023 -Novice 2 2023 -Novice 3 2023 -Novice 4 2023 -Novice 5 2023 -Novice 6 2023 -Novice 7 2023	
Min 16 yo	Elementary	Snaffle	Min 6 yo	-Elem 1 2023 -Elem 2 2023 -Elem 3 2023 -Elem 4 2023 -Elem 5 2023 -Elem 6 2023	
Min 16 yo	Medium	Snaffle	Min 6 yo	-Med 1 2023 -Med 2 2023 -Med 3 2023 -Med 4 2023 -Med 5 2023 -Med 6 2023	

Min 16 yo	Advance-Medium	Optional	Min 6 yo	-AdvMed 1 2023 -AdvMed 2 2023 -AdvMed 3 2023 -AdvMed 4 2023 -AdvMed 5 2023 -AdvMed 6 2023	
Min 16 yo	Advance	Optional	Min 7 yo	-Adv 1 2023 -Adv 2 2023 -Adv 3 2023 -Adv 4 2023 -Adv 5 2023 -Adv 6 2023	-YR Preliminary -YR Team -YR Individual -YR Freestyle
Min 16 yo	Small Tour Level	Optional	Min 7 yo		-PSG -Inter I -Inter I Freestyle
Min 16 yo	Medium Tour Level	Optional	Min 8 yo		-Inter A -Inter B -Inter II -Inter A/B Freestyle
Min 16 yo	Big Tour Level	Double	Min 8 yo		-GP -GPS -GP Freestyle

109.2 JUNIOR LEVELS AND COMPETITIONS

Athletes Age	Levels of Competition	Double / Snaffle	Horse Age	NF Tests	FEI Tests
< 16 yo	Introduction	Snaffle	Min 4 yo	-Intro 1 2023 -Intro 2 2023 -Intro 3 2023 -Intro 4 2023 -Intro 5 2023 -Intro 6 2023	
<16 yo	Preliminary	Snaffle	Min 4 yo	-Prelim 1 2023 -Prelim 2 2023 -Prelim 3 2023 -Prelim 4 2023 -Prelim 5 2023 -Prelim 6 2023	
<16 yo	Novice	Snaffle	Min 5 yo	-Novice 1 2023 -Novice 2 2023 -Novice 3 2023	

				-Novice 4 2023 -Novice 5 2023 -Novice 6 2023	
<16 yo	Elementary	Snaffle	Min 6 yo	-Elem 1 2023 -Elem 2 2023 -Elem 3 2023 -Elem 4 2023 -Elem 5 2023 -Elem 6 2023	
< 16 yo	Medium	Snaffle	Min 6 yo	-Med 1 2023 -Med 2 2023 -Med 3 2023 -Med 4 2023 -Med 5 2023 -Med 6 2023	

- Events may include other separate Competitions which must be specified on the Schedule and approved by **NF**, i.e. Separate Classes for Arabian Horses
- Ponys are allowed in all competitions for children and juniors, and for Introduction and Preliminary levels of all age categories.
- In order for the result to be counted as a qualifying result and for the rider to demand the prize and rosette set in the invitation there must be a **minimum 3 entries** in the competition. If a rider in such class cancels the entry on the day of the show, due to rider's illness or horse illness that can be proved by a doctor's note or veterinary note, the class can still be counted for, and the two remaining riders will get their prizes and qualifying results.
- **Any class can be put together when running in consecutive levels as one class if the number of entries are less than 3 in each of the classes.**
-

Article 110. Levels of Competitions:

The National Dressage competitions are divided into following classes:

- Introduction Class
- Preliminary Class
- Novice Class
- Elementary Class
- Medium Class
- Advanced Medium Class
- Advanced (including PSG)
- Intermediate I

Article 111. Tests:

1. Each Competition has its own test. The Official Dressage tests are published on the authority of the **NF** and can in no case be modified or simplified without the approval of the **NF**. Tests are either **NF** or **FEI**.

2. The NF Tests can be downloaded at the homepage of NF: www.uaeerf.ae
3. **FEI** tests may also be used in National competitions. Only the latest versions must be used. The tests can be downloaded at the homepage of **FEI**: www.fei.org
4. At National Events **rising trot** is allowed in Intro, Preliminary and Novice tests. Sitting trot is compulsory from Elementary and upwards apart from where it is stated in the tests i.e., option of rising in medium trot or on a stretching circle.
5. Ponys are allowed in all competitions for Juniors and for Senior Levels of Introduction and Preliminary tests.

Article 112. Execution of the Test:

1. Sound of bell. After the sound of the bell, the Athlete must enter the arena at A within forty-five (45) seconds. In the Freestyle, the Athlete has forty-five (45) seconds to signal to start the music and must enter the arena within thirty (30) seconds of the music starting. During Freestyle tests, in case of technical failure or delay in start of the music, the Judge at C can interrupt the count and re-continue after the problem has been resolved. The Judge at C is responsible for the bell and clock/time.

- In the event that the Horse starts to defecate or urinate after the judge rang the bell, but before the start of the test, the clock will be stopped until the Horse is ready to continue at which point the clock will be restarted.
- **Entering the Arena:** For Competitions where it is not practical for the Athletes to ride their Horses around the outside of the arena prior to entering the arena, Athletes are permitted to enter the arena before the bell is sounded. After the bell has sounded, the Athlete starts the test from within the arena.

2. Salute. Athletes must take the reins and whip (if used) in one hand at the salute, then lower the free hand to their side and nod their head. An incorrect salute or no salute will incur a penalty of 0.5% (zero point five percentage points) deducted per each failed execution by each judge.

3. Error of course. When an Athlete makes an “error of course” (takes the wrong turn, omits a movement, etc.) the Judge at C warns him, by sounding the bell. The Judge at C shows him, if necessary, the point at which he must take up the test again and the next movement to be executed, then leaves him to continue by himself. However, in some cases when, although the Athlete makes an “error of course”, the sounding of the bell would unnecessarily impede the fluency of the performance - for instance if the Athlete makes a transition from medium trot to collected walk at V instead of at K, or, cantering up the centre line from A, makes a pirouette at D instead of at L - it is up to the Judge at C to decide whether to sound the bell or not. However, if the bell is not sounded at an error of course and the test requires the same movement to be repeated and the Athlete again makes the same error, the Athlete is only penalised once.

The decision as to whether an error of course has been made will be at the sole discretion of the Judge at C. The other Judges’ scores will be adapted accordingly.

4. Error of Test/Execution. When an Athlete makes an “error of the execution of the test” (trots rising instead of sitting, etc) he/she must be penalised as for an “error of course”. In principle, an Athlete is not allowed to repeat a movement of the test unless the Judge at C decides on an error

of course (sounds the bell). If, however, the Athlete has started the execution of a movement and attempts to do the same movement again, the Judges must consider the first movement shown only and at the same time, penalise for an error of course.

5. Unnoticed Error. If the Ground Jury has not noted an error, the Athlete has the benefit of the doubt and will therefore not be penalised for the error.

6. Penalties

6.1. “Error of Course” and Error of Test/Execution:

Every “error of course” or error of test/execution, whether the bell is sounded or not, must be penalised, except as noted above.

- First error – deduction of 0.5% from the total score
- Second error – deduction of 1% from the total score
- Third error - Elimination

6.2. Other Penalties – Technical Faults:

It is the responsibility of the Judge at C to decide whether a penalty should be applied, and the other judge's sheets should be marked accordingly to ensure consistency.

All of the following are considered technical faults, and zero-point five percentage points (0.5%) will be deducted per fault by each Judge, but these deductions are not cumulative and will not result in Elimination (including for Freestyle tests):

Description of Technical Fault	Comments
Entering the space around the arena with a whip (when the use of a whip is not permitted) or with boots/bandages on the horse's legs or with discrepancy in Athletes dress	
Entering the dressage arena with a whip (when the use of a whip is not permitted) or with boots / bandages on the horse's legs or with discrepancy in Athlete's dress (e.g. lack of gloves)	If the test has already started before the discrepancy has been noticed, the Judge at C stops the Athlete and if needed and possible, an assistant may enter the arena to remove the item(s). The Athlete then continues the test, from the movement where they were stopped. The marks given before they were stopped are not changed
Entering the arena before the sound of the bell. Or beginning the test before the sound of the bell if starting from the inside	
Not entering the arena within forty-five (45) seconds after the bell, but within ninety (90) seconds	
For Freestyle tests, entering the arena after more than thirty (30) seconds of music	

Using voice or clicking the tongue repeatedly	
Athletes not taking the reins in one (1) hand at the salute	
Falling out of the arena because of loss of balance during the competition when the arena is left not closed (no gate at A) and /or boards under 30cms (if a horse is disobedient and runs out of the arena it is eliminated)	

If the Freestyle test is longer or shorter than stipulated on the test sheet, zero-point five percentage points (0.5%) will be deducted from the total Artistic score, for other technical faults zero-point five percentage points (0.5%) will be deducted per fault from the Technical score.

Penalty Percentage Points: the penalty percentage points are deducted on each Judge's sheet from the total points obtained by the Athlete. In Junior classes, when using the judging system with two judging procedures, penalty percentage points must be deducted from both procedures (technical judges and quality judges).

7. Reasons for Elimination:

- a. **Lameness.** In a case of marked lameness, the Judge at C informs the Athlete that he is eliminated. There is no appeal against this decision.
- b. **Resistance.** Any resistance which prevents the continuation of the test longer than twenty (20) seconds is punished by Elimination. However, resistance that may endanger Athlete, Horse, Judges or the public will be result in elimination for safety reasons earlier than within twenty (20) seconds. This also applies to any resistance before entering the Dressage arena.
- c. **Fall.** In the case of a fall of a Horse and/or an Athlete, the Athlete will be Eliminated.
- d. **Leaving Arena During Dressage Test.** A Horse leaving a completely closed arena (at gate at A), with all four (4) feet, during a Dressage Competition between beginning and end of the test will be Eliminated.
- e. **Outside Assistance.** Any outside help by voice, signs, earphones and/or electronic communication devices is considered illegal or unauthorized assistance to an Athlete or to his/her Horse. Illegal or unauthorized assistance will result in Elimination of that combination.
- f. **Bleeding:** If the Judge at C suspects fresh blood anywhere on the Horse during the test, they will stop the Horse to check for blood. If the Horse shows fresh blood, it will be eliminated. The elimination is final. If the Judge thoroughly examines the Horse and clarifies that it has no fresh blood, the Horse may resume and finish its test.
- g. **Other Reasons for Elimination:**
 - The performance is against the welfare of the Horse and/or shows abusive riding.

- Horse and Athlete combination not entering the Competition arena within ninety (90) seconds after the bell. Except where a valid reason thereto has been informed to the Judge at C (valid reason may be losing a shoe, etc.)
- Riding with non-permitted equipment which is not covered under these Rules.

8. Execution of Movement at Certain Point. In a movement, which must be carried out at a certain point of the arena, it should be done at the moment when the Athlete's body is above this point, except in transitions where the Horse approaches the letter from a diagonal or perpendicular to the point where the letters are positioned. In this case, the transitions must be done when the Horse's nose reaches the track at the letter so that the Horse is straight in the transition. This includes the execution of flying changes.

9. Beginning/End of Test. A test begins with the entry at A and ends after the salute at the end of the test, as soon as the Horse moves forward. Any incidents before the beginning or after the end of the test have no effect on the marks. The Athlete should leave the arena in the way that is prescribed in the text of the test.

10. Details to The Freestyle Test. An Athlete must enter the arena within thirty (30) seconds of the music starting. At the beginning and end of a Freestyle Test a halt for the salute is compulsory on the centerline facing the Judge at C. The test time will start after the Athlete moves forward after the halt and stop with the final salute.

Article 113: Time and Technical Failure:

- 1. Timing of Tests: only** Freestyle tests are timed. The time shown on all other test sheets is for information only. The Judge at C is responsible for bell and clock/time. A clock showing forty-five (45) seconds should be used whenever possible and should always be clearly visible for the Athlete.
- 2. Interruption:**
 - In case of any technical failure that will interfere with the competition, the Judge at C shall ring the bell. It is recommended that in clear cases of external disturbances, the same procedure is applied. During extreme weather conditions or other extreme situations, the Judge at C may ring the bell for interruption of the test. The Technical Delegate / OC may also suggest to the Judge at C to stop the Competition. The affected Athlete should return to complete their test when conditions so permit.
 - During Freestyle tests, in case of technical failure or delay in start of music, the Judge at C can interrupt the count and re-continue after the problem has been resolved.
 - In the case of an Athlete's music failing during a Freestyle Test and in cases where there is no back-up system, the Athlete can, with the permission of the Judge at C, leave the arena. There should be minimum interference with the starting times of the other Athletes. The affected Athlete should return to complete or restart their test during a scheduled break in the Competition or at the end of the Competition. The Judge at C, after conferring with the Athlete, will determine when the Athlete should return to the arena. It is up to the Athlete whether to restart the test from the beginning or to

commence from the point where the music failed. In either case, the marks already given will not be changed.

- If there are foreign objects in the arena which could have an influence on performance, the test must be stopped, and the Athlete can continue once the object has been removed.
- If an Athlete must restart a Freestyle test, they can choose to start from the beginning or where they stopped. In any other test, the Athlete must restart from where they were stopped unless the Athlete was required to leave the arena and warm up again, in which case the Athlete must be given the option to start their test from the beginning or from where they were stopped. Any scores given before the interruption remain.

Article 114. Judges' Sheets:

1. General:

- a. The Judges' sheets have two (2) columns: the first for the Judge's original mark, the second for the corrected score. Any corrected score must be signed by the Judge having made the correction. Judges' scores must be endorsed by the Judge. After the Judge signs and gives away his Judge's sheets the marks can no longer be changed.
- b. There is also a column for the Judge's remarks, where the Judge should state the reason for the judgment as far as possible. Giving remarks is compulsory when giving marks of 5.5 and below and Judges' sheets should be available to the Athletes after the class.
- c. The final results of the class must be signed by the Senior judge and the Chief Scorer.

2. Markings:

- a. All movements, and certain transitions from one movement to another and Collective Mark, which have to be marked by the Judges, are numbered on the Judge's sheet.
- b. They are marked from zero (0) to ten (10) by each Judge, zero (0) being the lowest and ten (10) the highest mark. All half marks from 0.5-9.5 may also be used both for movements and collective mark, at the discretion of the judge.
- c. The scale of marks is as follows:

10	Excellent	7	Fairly Good	4	Insufficient	1	Very Bad
9	Very Good	6	Satisfactory	3	Fairly Bad	0	Not Executed
8	Good	5	Sufficient	2	Bad		

“Not Executed” means that practically nothing of the required movement has been performed.

3. Collective Marks:

- a. After the Athlete has finished their performance, a collective mark is awarded for General impression.
- b. The Collective Mark and certain difficult movements can be given a coefficient fixed by the FEI or NF.

Article 115: Results and Calculation of Scores:

After each performance and after each Judge has given their collective mark and signed the sheets, these are passed into the hands of scorers. The marks are multiplied by the corresponding coefficients, where applicable, and then totaled.

1. **Individual Classification:** The individual classification is decided as follows: In all Competitions the winner is the Athlete having obtained the highest total percentage, the second placed Athlete is the one with the next highest total and so on.
2. **Ties:**
 - In the case of equality of percentage of the first three (3) places, the highest total median score of the Judges will decide the placing. The median score is the middle number. To calculate the median of a set of scores, the scores need to be put in ascending numerical order, eg. 68.5% 69% 70% 70.5% 71%, of which 70% is the median score in this case.
 - Ties in Freestyle: In case of equality of percentage in a Freestyle Test for the first three (3) places, the higher artistic marks will decide on the better placing. Should the artistic mark be the same, the higher mark for harmony will decide. If still tied the higher mark for choreography will decide. If still tied, then both Athletes are given the same placing.
3. **Calculation of Scores:**
 - After each performance, the percentage awarded by each Judge will be calculated and published separately and provisionally, in addition to the general total.
 - The total score for the classification is obtained by adding the total points on each of the Judges' sheets and converted to percentage. Penalty percentage points for errors of course and technical faults are deducted from the total score (per Judge). All results and scores (to include artistic, technical and quality % scores) must be published in percentages with three (3) decimals after the decimal point.
 - The reference maximum total points to be used for the calculation is indicated on each test sheet.
 - For Example: Grand Prix: 460 points.
 - Grand Prix Freestyle: 200 points for technical and 200 points for artistic
 - Percentages: all percentage calculations must be rounded up or down to three (3) decimals after the decimal point as per the following principle and example: 0.0011-0.0014 down; 0.0015-0.0019 up.
 - In tests with technical marks only, the total average percentage per Judge is calculated by adding the total marks per movement (multiplied by the corresponding coefficients) divided by the maximum total points and multiplied by 100.
 - In Freestyle tests, the total average percentage per Judge is calculated by adding the technical and artistic percentages and dividing them by two (2).
 - In tests for Children with technical and quality marks the final percentage is obtained by adding the technical (or average of three (3) technical) and quality percentages divided by two.
 - The final percentage is obtained by adding the total average percentage per Judge divided by the number of Judges:

Total Average Percentage per Judge	Percentage %
Judge at E	69.990%
Judge at H	70.333%
Judge at C	70.205%

Judge at M	71.120%
Judge at B	69.660%
Final Percentage:	70.262%

4. Publishing of Results:

- All results published in percentages must have numbers to three (3) decimals after the decimal point.
- If an Athlete withdraws prior to a Competition, retires, is eliminated during their performance, or does not present for the test (a "No Show"), the words "withdrawn", "retired", eliminated " or "no show" must appear after the Athlete's name in the result sheet.

Withdrawn	The Athlete has cancelled their start prior to a test with a valid reason accepted by the President of the Ground Jury
Retired	The Athlete started the test but abandoned at some point within the test
Eliminated	The Athlete has started, but had to end the performance due to a breach of the Dressage Rules
No Show	The Athlete did not present for the Test, without further information

Article 116. Entries:

1. Organizers will make appropriate arrangements to invite participants for each level competition included in the event's schedule. Such entries will then be forwarded to **NF** who will ensure that all eligible horses and riders can enter.
2. Closing dates for NF events will be stated on the Schedule, or it will be four (4) days before the competition. Entries received after the closing date prior to an event may not be accepted.
3. Entry Fees will be set by the NF and will be clearly marked on the Schedule.
4. Entry Fees are to be paid on entry and before the start of the competition. Failure to do so will incur elimination from the event.
5. Any cancellation or withdrawal completed less than 24 hours before the start of the competition will be subject to a 50% penalty. This penalty shall be waived if a Veterinary note is presented to the O.C. within that 24-hour period prior to the competitions' start. If a rider registers for a competition, does not cancel within the stipulated time limit and does not compete on the day, all of the entry fees will be forfeited to offset the event running costs.
6. Any rider not paying an outstanding entry fee will not be allowed to compete at any center until this outstanding entry fee has been paid. All Equestrian centers will be updated of outstanding payments via the NF. Failure to produce a veterinary or doctors' certificate within the stipulated time stated - entry fees will be forfeited in total.
7. Start Lists will be published and sent out via WhatsApp Dressage Group Chat by 4pm two days before the competition by the Group Chat Admin. Substitutions will be at the Centre or Clubs discretion for National Events.
8. All Classes must have 3 riders competing for the results to be accepted as a Class.

9. Where there are reduced entries, classes may be combined at the discretion of the Dressage committee / event organizer.
10. A rider may only competitively participate in a maximum of 3 entries per National Show, if the rider has additional mounts/horses to ride then those must be HC'd. Entry fee will apply, judge's sheet can be collected and will be ridden last in the said competition

Article 117. Schedules:

All schedules must give the dates and location of the Event and the dates by which entries must be received in accordance with the following check list:

1. The words "UAE Equestrian & Racing Federation Competition"
2. The Disciplines in which Competitions will be held
3. The programme of Competitions
4. The category of eligibility according to **NF** rules
5. Whether the Competitions will be indoors or outdoors
6. The type and dimensions of the schooling areas and the Competition arenas
7. The stabling and accommodation available
8. The value of the prizes and their distribution with the actual break down of each placings in each class
9. The national veterinary health requirements
10. The name of the Senior Judge/Ground Jury
11. The name on the Chief Organizer / Steward(s)
12. Any other relevant details, such as whether a café / food venue is open doing competition timings
13. The Schedule must also give the time and place of the commencement of the Horse inspection under the Veterinary Regulations if this will be held.

Article 118. Organizers:

1. The Organizers must appoint all Judges and Officials from **NF** list for national events or approved judges from other countries, or **FEI**-judges.
2. For **F.E.I.** International Events **NF** will appoint Officials from the **F.E.I.** recommended list and cover the costs of international Judges and Officials.
3. The Organizers must submit to the Secretary General of **NF** within five (5) business days of completion of the event, the following in respect of each competition:
 - a. A list of all starters, together with their results.
 - b. Lists of all placings should be signed by the Senior Judge and the Chief Scorer (National Events) or two members of the Ground Jury (International Events) of the Competition.

Article 119. Arena and Exercise Arenas (For Diagram see annex arena):

1. At National **NF** events and National Championships, the competition arena must be inspected and approved by The President of the Ground Jury (highest qualified judge of the day).

2. **Arena Specifications:** The arena, flat and level, must be either sixty meters (60 m) long and twenty meters (20 m) wide or forty meters (40 m) long and twenty meters (20 m) wide. The arena surface shall be approved by the NF. The measurements above are for the interior of the enclosure, which must be separated from the public by not less than ten meters (10 m). Exception from this may be granted by the NF. For indoor competition, the arena should be two meters (2 m) from the wall.
3. The enclosure itself must consist of a low white fence (rails which must not be solid), thirty centimeters (30 cm) high. The section of fence at 'A' should be easy to remove, to let the Athletes in and out of the arena. The width of the entrance must be at least two meters (2 m). The rails of the fence should be such as to prevent a horse's hoofs from being caught. The rails may not contain any metal components.
4. It is recommended to keep the part of the fence at A closed during each Athlete's performance and between tests, until the Judge at C gives the starting signal.
5. **Letters:** The letters outside the enclosure shall be placed about fifty centimeters (50 cm) from the boards and clearly marked. It is compulsory to place a marker on the fence itself, level with and in addition to the letter concerned. Advertising is not allowed on letters or on letter holders. Letters should also be visible to the public.
6. **Placing of Judges:** Three (3) Judges must be placed along the short side, on the outside of and a maximum of five meters (5 m), minimum of three meters (3 m) from the arena at outdoor Competitions and preferably a minimum of two meters (2 m) at indoor Competitions; the Judge at C on the prolongation of the center line, the two (2) others (M and H) two meters fifty (2.50 m) from and on the inside of the prolongation of the long sides. The two (2) Side-Judges (B and E) must be placed on the outside of and a maximum of five meters (5 m), minimum three meters (3 m) from the arena at B and E respectively; at indoor Competitions, preferably a minimum of two meters (2 m). With three (3) Judges only, the Judges must be seated as follows: two (2) on the short side (at C and at either H or M) and one (1) on the opposite long side (B or E).
7. **Judges' Hut:** A separate hut or platform must be provided for each Judge. It must be raised at least fifty centimeters 50cm above the ground to give the Judges an unobstructed view of the arena. The booth/hut must be large enough to accommodate four (4) persons. The OC must ensure that the Judges' Huts provide shelter, are suitable heated or cooled depending on weather conditions.
8. Only officiating people (to include Officials fulfilling promotion requirements) are allowed in the Judges' huts. Any exception must have prior approval of the PGJ or the Senior Judge. No media nor recording equipment are allowed in the Judges' hut.
9. **Entering the arena:** For Competitions where it is not practical for the athletes to ride their horses around the outside of the arena prior to entering the arena, athletes are permitted to enter the arena before the bell is sounded. After the bell has sounded, the athlete starts the test from within the arena.
 - a. In competitions where it is possible to ride a horse around the outside of the arena, the athlete is allowed to enter the space around the arena before the bell is sounded but may only enter the arena after the bell has been sounded.
 - b. The Judge at C is responsible for bell and clock/time.
10. **Warm-up Arena:** On no account and under penalty of disqualification, may an Athlete/Horse use the competition arena at any time other than during their performance

in a competition or when at the discretion of the OC the main arena is open for training.
A suitable size warmup arena must be provided and approved by the NF.

11. **Interruption:** refer to Article 113.2

Article 120. Medical and Veterinary Services:

In compliance with **UAE National Law** no event may commence without the presence of Medical Services. Show Organizers are therefore obliged to ensure that Medical Services, together with Treating Veterinary Services are present prior to and throughout their event.

Article 121. Starting Possibilities:

1. **Rider/Horse combination:** A rider/horse combination can start in two different classes but with no more than one level difference, i.e.: Intro-Preliminary, Preliminary-Novice, Novice-Elementary, Elementary-Medium, Medium-Advanced Medium, Advanced Medium-Advanced, Advanced-Intermediate 1
2. **Rider:** A rider can start:
 - a. In different classes – with no more than one level difference if on the same horse.
 - b. In the same class but with different horses
 - c. The O.C. may restrict the number of entries from a rider if the total number of entries for the class exceeds the possible maximum number of participants.
 - d. Can only competitively compete on a maximum of 3 entries, additional entries are to be HC'd.
3. **Horse:** A horse is allowed to start:
 - a. Not more than two (2) times per day up to Small Tour / Intermediate 1
 - b. Once a day on Medium Tour and Big Tour level.

Article 122. Identification:

Where registration numbers are issued to competitors the correct numbers must always be worn by the horse when taking part in competitions and during the Show.

Article 123. Hors Concours:

1. A Horse and or Rider that is permitted to take part in a competition Hors Concours by the **NF** will not be eligible for any prize or points in that class.
2. Hors Concours are permitted up to Prix St. George level with permission from the **NF**.
3. Horse and or Rider may compete without full registration with **NF** on proof of vaccination during a season as HC with the approval of the NF and the organizing Committee.
4. A horse or pony may not be ridden competitively in a class if it has already been ridden Hors Concours by another rider in the same competition.

Article 124. Callers:

1. Callers can be used in the following classes for National Competitions: Introduction, Preliminary, Novice and Elementary levels.
2. Callers are forbidden at National Championships or **F.E.I.** International Challenge/Championships.

Article 125. Warming-Up:

1. At **F.E.I.** International Dressage Competitions, Regional and National Championships it is prohibited under penalty of elimination for anyone to school a horse other than the person riding in the competition
2. In all National Competitions at Intro and Preliminary levels the horse may be ridden by one other competitor.
3. In all other National competitions, the horse may not be ridden by another person other than the competitor unless for the purpose of warming-up as stipulated below or bringing their horse to and from the warming-up arena.
4. Warming-up activities by another person other than the competitor shall be restricted to walk or trot on a long rein, lunging, or hand walking.
5. Warming-up with a contact and/or schooling the horse by another person than the competitor is not allowed under penalty of elimination
6. All warming-up activity is to be done within line of sight of the steward.
7. If the warm-up arena is becoming overcrowded those not competing on the ongoing class may be asked to leave the arena. If so necessary, the Steward or Senior Judge can limit the number of horses in the warm-up arena so that each horse has a minimum of 45 minutes to its allocated starting time.
8. Coaches who train riders during warm-up must stand either outside the fence or in a corner of the riding arena and not disturb other riders.
9. Coaches and Riders may use electronic devices while in the warmup arena, the Rider must remove their devices prior to entering the area around the competition arena. Failure to do so will result in Elimination.
10. Removal of boots, putting on jackets, removing electronic devices, etc... It should be done at the edge of the warmup arena so as not to interfere with other riders.

Article 126. Unforeseen Circumstances:

1. Every eventuality cannot be provided for in these Rules. In any unforeseen or exceptional circumstances, it is the duty of the Ground Jury or Senior Judge to make a decision in a sporting spirit and approaching as nearly as possible to the intention of these Rules.
2. In the event of any ambiguity with the interpretation of **NF** Rules, the current **F.E.I.** Dressage Rules published in English language will take precedence over versions in any other language.

CHAPTER IV THE UAE EQUESTRIAN FEDERATION CHAMPIONSHIPS

Article 127. Place and Date:

The United Arab Emirates Equestrian and Racing Federation Championships in Dressage take place at the end of each season which shall be October through May.

Article 128. Starting possibilities:

Each combination of Horse and Rider that competes can gain points throughout the season and will be eligible to compete at the Championships riding in the highest section in which points were achieved.

Article 129. Numbers to Qualify:

1. For the Preliminary, Novice, Elementary and Medium classes the top 10 horses/rider combinations will automatically qualify as per the last published league/points table at the end of the season. For Advanced Medium and above classes, ALL horse/rider combinations will automatically qualify.
2. Should there be a tie for any of the 10th places, the highest-placed horse will be offered the 10th.
3. A rider may qualify no more than 2 horses over two different levels for the **NF** Championships.
4. Where a horse has qualified by winning points with more than one rider the combination of horse and rider that has gained the most points at the higher level will be given preference to compete.
5. Should the rider with the higher number of points choose not to compete on this horse the next highest placed combination on the horse may do so.
6. Only the horse and rider combinations that have gained points throughout the season will be permitted to compete, no riders will be permitted to be substituted for Championships.

Article 130. Competitions in the National Championships:

There will be held Championships in the following Competitions:

1. Preliminary Class – Junior and Senior
2. Novice Class – Junior and Senior
3. Elementary Class
4. Medium Class
5. Advanced Medium Class
6. Advanced Class

The top five (5) riders from classes 1-6 will qualify for the freestyle for their level.

- Preliminary Freestyle
- Novice Freestyle
- Elementary Freestyle
- Medium Freestyle
- Advance Medium Freestyle
- Advanced Freestyle

CHAPTER V

FEI WORLD DRESSAGE CHALLENGE SELECTION/QUALIFYING RULES

CHAPTER VI CEREMONIES, PRIZES AND EXPENSES

Article 131. Ceremonies:

1. Participation in the Prize-Giving ceremony of placed Athlete/Horse combinations is compulsory. Failure to do so entails losing the classification and prizes (rosette, plaque, prize in kind and prize money). Exception to this rule can only be granted by the Senior Judge (National Competitions) or President of the Ground Jury/Foreign Technical Delegate and /or the Judge at C or Chief Steward (International Competitions) for the particular Competition.
2. Competitors are obliged when required to parade mounted or unmounted.
3. Dress and saddlery must be the same as in the competition. However, black, or white bandages, boots, earplugs on horses and carrying a whip are allowed. For safety reasons, Athletes are not allowed to carry flags or other items during prize giving. Only winner rugs/blankets are allowed to be worn by Horses during the prize giving ceremony.

Article 132. Prizes:

1. Refer to **Article 117. Schedules** to show required information.
2. The amount of Prize Money and type and value of prizes if in kind, must be stated in the schedule and is unrestricted.
3. Prize Money for Sponsored Competitions will be awarded as advertised regardless of the number of Starters.
4. The minimum Prize Money for Unaffiliated Club Competitions will be based on the Entry Fees and will be awarded according to the placing table. The minimum prize money will start at the lowest placing eligible for Prize money and must be equal to the Entry Fee. This will rise higher going up to first place.
5. In all National Competitions prizes and/or rosettes will be awarded according to the placing scale below. From Medium and above the first three riders on the result list shall be awarded prizes and rosettes.
6. With the consent of **NF** additional rosettes may be awarded for competitions during an event.
7. Organizers are encouraged to award rosettes up to at least 6th place for National Events. Where classes are split into sections the scale applies to each section.

The Minimum Placing Scale is shown below:

Place	Placing Scale
1st	1-4 Starters
2nd	5-8 Starters
3rd	9-12 Starters
4th	13-16 Starters
5th	17-20 Starters
6th	21-24 Starters

**** Note:** that in Medium level and above the Minimum Placing Scale will not apply and at the discretion of the NF Dressage Committee

8. **Prize Money Distribution:** will be distributed according to the following table, subject to change is at the discretion of the NF Dressage Committee.

Prize Money AED	1 st Place	2 nd Place	3 rd Place	4 th Place	5 th Place	6 th Place
Up to 1000	450	350	200	Rosette	Rosette	Rosette
1001-1500	675	525	300	Rosette	Rosette	Rosette
1501-2000	900	700	400	Rosette	Rosette	Rosette
2001-2500	1125	875	500	Rosette	Rosette	Rosette
2501-3000	1200	900	600	300	Rosette	Rosette
3001-3500	1400	1050	700	350	Rosette	Rosette
3501-4000	1520	1120	760	400	200	Rosette
4001-4500	1710	1260	855	450	225	Rosette
4501-5000	1850	1300	750	500	350	250

9. The percentage of breakdown is predicated and is subject to change based on the total number of participants and value of prize money subject to change in the event that participant numbers are lacking and at the discretion of the Dressage Committee. But above based on the following breakdown of Prize Money Value per Class:

- Prize Money of 2500 aed or less: 1st 2nd and 3rd places receive cash prizes accordingly (45%,35% and 20% respectively)
- Prize Money of 2501-3500 aed: 1st 2nd 3rd and 4th places receive cash prizes accordingly (40%, 30%, 20% and 10% respectively)
- Prize Money of 3501-4500 aed: 1st 2nd 3rd 4th and 5th places receive cash prizes accordingly (38%, 28%, 19%, 10% and 5% respectively)
- Prize Money over 4501 aed: 1st 2nd 3rd 4th 5th and 6th places receive cash prizes accordingly (37%, 26%, 15%, 10%, 7% and 5% respectively)

**** NOTE:** that in Classes with Prize Moneys over 2500aed and participant numbers are at 3 only, then the breakdown of prize money is 45%,35% and 20% respectively

**** NOTE:** in classes that are composed of multiple levels because of limited participants, the prize money awarded will be based on the test ridden and the placement payout as per the schedule.

Article 133. Expenses:

1. The OC shall meet the travelling, accommodation, and meals Expenses of all Officials.
2. **NF** appointed Officials whose Expenses are to be paid by the OC shall be appointed with the agreement of the OC.
3. National judges and chief steward shall be paid not less than 100 AED per hour.
4. International Judges shall be paid 200 AED per hour and travel.

CHAPTER VII RIDERS

Article 134. General:

Riders include both female and male athletes, unless otherwise stated.

Article 135. Registration – Riders:

1. To be eligible to compete, all riders must be registered with **NF**.
2. The final decision regarding all licenses remains solely and exclusively with **NF**.
3. Registration Fees will be set by **NF**.

Article 136. Person Responsible:

1. Person Responsible: In all matters the Person Responsible (**P.R.**) will be the rider. As per **F.E.I.** General Regulations.
2. If a rider is under 18 years of age, the Person Responsible (**P.R.**) for his horse must be nominated by **NF** or Chef d'Equipe and may be the Owner of the horse, a Parent of the rider in question, Team Coach, Team Veterinarian, or some responsible Adult. If **NF** and/or Chef d'Equipe fail to nominate the P.R. anyone or more of the Owner of the horse, a Parent of the rider, the Chef d'Equipe, Team Coach and or Team Veterinarian may be viewed as the **P.R.**
3. In some circumstances, the Legal Department may be able to establish that a minor is involved, but the determination and the designation of the **P.R.** for such a minor remain the responsibility of **NF** and the relative Club Manager.
4. However, in addition to the above and in certain circumstances, **NF** may consider that some or all of the responsibilities rest with the Owner, relative Club Manager, Official Trainer and/or Official Veterinary Surgeon. In such cases, **NF** may also, if appropriate, apportion responsibility/liability to any of them.
5. The term 'Official' necessitates verifiable appointment by **NF** or Club relative to appointee in question, having been made and authorized by **NF** or Club relative prior to competition involved.

CHAPTER VIII HORSES

Article 137. Eligibility:

1. Only horses, which are registered with **NF**, are eligible to compete at Events run under the Rules of **NF**. (Hors Concours included)
2. **NF** may, at its sole discretion, permit foreign riders/horses (i.e.) those affiliated to a foreign Federation) to compete in national competitions subject to the following conditions:
3. Written application for such permission is received by **NF** from Foreign Federation.
4. Full documentation is received by **NF** in respect of registration of both horse and rider.

Article 138. Registration – Horses:

1. All horses entered in events must be registered with **NF**.
2. No horse under 4 years of age may be registered.
3. To secure registration the owner is obliged to provide the **NF** with Identification Documents and with up-to-date equine influenza vaccination details, both completed by a qualified and **NF** approved veterinary surgeon.
4. The United Arab Emirates Equestrian and Racing Federation will keep a register of horses showing full details.

Article 139. Horses Name:

1. Horses must only be registered, entered, and compete in competitions under their registered names.
2. Should an owner wish to change a horse's name, application must firstly be made to UAEERF for authorization and subsequent amendment of the register.
3. Animals holding **F.E.I.** passports will be registered with and may only compete under their **F.E.I.** registered names.

Article 140. Horses – Age:

1. Horses may compete if they are a minimum of:
 - 4 years of age for “Adults” Preliminary & Novice
 - 5 years of age for “Adults” Preliminary to Elementary
 - 6 years of age for “Children” Preliminary to Elementary
 - 6 years of age for Medium to Advanced
 - 7 years of age to PSG
 - 8 years of age in Intermediate II to Grand Prix
2. The age is counted from 1st January of the year of birth

Article 141. Competitive Conditions:

The PR, parent or guardian is responsible for the welfare of their horse competing at an event. The senior judge, where appropriate after consultation with a Veterinarian, can give permission to start or eliminate a horse if the level of performance, fitness, injuries, or general condition is detrimental to the welfare of the horse or the sport's reputation.

CHAPTER IX DRESS

142. Article Dress Code - General:

1. Competitors must wear the dress appropriate to Dressage and be properly dressed when appearing before spectators, media or whenever they are in the confines of the arena and at presentation of prizes.
2. In very warm weather, the Jury or Senior Judge may permit competitors to remove their jackets and stocks along as the Athlete is wearing an appropriate white shirt.
3. If competitors are not properly dressed, they will be eliminated except for technical faults as mentioned in Article 113, by the Ground Jury.
4. Stocks are optional in Introduction to Elementary Levels.

Article 143. Advertising:

Competitors or their horses are not permitted to carry or wear any form of advertising material while in the arena, unless specifically permitted by **NF**. (Ref. Art. 149)

Article 144. Jacket/Coat:

1. From Introductory to Medium Level – National Service Dress or Short Jacket with correctly tied stock or collar shirt and tie and protective head gear. The stock or tie to be white, off white. Stock or tie is optional from Introductory to Elementary Level.
2. Advanced Medium and above – Tailcoat with protective hat or top hat, or National Service Dress to be worn with protective hat.
3. National Service Dress, Tailcoats or short Jackets to be worn and may be of any plain conservative dark color.
4. National Riders eligible to wear **NF** Uniform may do so with permission from **NF**. National Riders competing in F.E.I. International events are obliged to wear the Official United Arab Emirates Equestrian and Racing Federation Jacket.

5. At the discretion of the Organizers, competitors may be permitted to ride without jackets and stocks/ties in excessively hot weather, but a suitable long/short sleeved shirt that fastens at the neck. No sleeveless shirts or vests are permitted.

Article 145. Hats:

1. As a general rule, a properly fastened Protective Headgear has to be worn by all Athletes (as well as any other person) at all times when mounted and by Children, Juniors and U25 for the Horse inspection.
2. Any Athlete (as well as any other person) violating this provision must immediately be prohibited from riding further until the protective Headgear is properly in place.
3. As a general rule, a properly fastened Protective Headgear is required to be worn by the Rider / Handler for trot up doing Horse inspections.
4. If any Athlete chooses to remove their Headgear at any time, whether permitted or not by these rules, such removal shall always be entirely at their own risk.
5. Protective Headgear formed as a top hat may be used. Protective headgear is defined in Appendix A in the FEI GRs.

Article 146. Breeches/Jodhpurs:

1. Must be plain white, off-white, or cream.
2. When worn with National Service Dress they may be of the color of the National Service Dress.

Article 147. Gloves

- Gloves must be worn, and should be white, off-white, or the same color as jacket. If gloves are not worn there will be a 0.5% deduction on the scoresheet.

Article 148. Boots:

1. Must be plain black or brown or the same color as the coat/jacket, may be top boots or jodhpur boots for National Competitions.
2. Half chaps may be worn in all National Competitions up to Elementary Level provided that they are identical leather to the boots and may not have any decoration of any sort.
3. Boots worn from Medium level and up or in F.E.I. International Dressage Competitions must comply with current F.E.I. Dressage Rule Article 431

Article 149. Spurs:

1. Spurs may be worn at all levels and are compulsory from Elementary level upwards.
2. Junior riders, in Junior classes, spurs are optional but if used, only blunt metal spurs no longer than 3.5cm in length, measured from the boot to the tip are allowed. Spurs with rowels are not permitted.

3. When Junior riders compete in adult classes they compete under the same regulations as for the seniors.
4. The spurs must be made of metal. The shank must be either curved or straight pointing directly back from the center of the spur when on the Athlete's boot. The arms of the spur must be smooth and blunt. If rowels are used, they must be blunt/smooth and free to rotate. Metal spurs with round hard plastic nobs are allowed ("Impulse" spur). "Dummy" spurs with no shank are also allowed.

Article 150. Whips:

1. For National competitions, whips may be used at all levels up to (and not including) Advanced Medium.
2. For National Championships or F.E.I. International Events whips are forbidden. The whip must be dropped before entering the space around the Competition arena or the Athlete will be penalized.
3. If whips are carried, they must not exceed maximum length 1:20m. Refer to current F.E.I. Dressage Rule 434.4 for description of whips permitted to be used.
4. Junior riders competing in National Competitions on Ponies (up to & inc.148cms) may carry a whip not exceeding 1m. Showjumping whips are not permitted.
5. No substitute for a whip may be carried in or around the vicinity of the show ground. Whips may be carried in either hand, but only in the left hand when saluting.

Article 151. Earphones:

Earphones and/or other electronic communication devices are strictly prohibited at National Dressage Competitions whilst competing and such usage is penalized by elimination. Earphones or similar devices are however permitted during training and warm-up.

CHAPTER X SADDLERY

Article 152. Saddles:

1. Saddlery and equipment must conform to these General Rules and to the special rules for each discipline and with current F.E.I. Dressage Rules. Saddles must be worn and be of English or Continental Style and must be black or brown for National events.
2. This may include all types of saddle except for western saddles, up to and including Elementary Level. Up to Elementary level, a jumping saddle is permitted but without showjumping attachments eg. breastplate. Cruppers are permitted.
3. The use of cruppers is permissible.
4. At medium level and above, dressage saddles must be used.
5. Seat Savers or saddle covers are not permitted.
6. Stirrup leathers and stirrup irons must be Dressage specific, showjumping stirrups are not permitted.
7. Stirrups must have closed branches with no attachments. The foot may not be fully or partially enclosed and must in no way be attached to the stirrups (for example with magnets)

or a grater style surface). Safety stirrups may be used and can have an opening on the outside branch. Side stirrups are not permitted.

Article 153. Saddle Clothes:

1. Saddle Cloths bearing the National Flag of the United Arab Emirates may only be worn by a competitor who is officially representing the United Arab Emirates at an F.E.I. International event.
2. Saddle pads should be white, contrast color and piping is allowed. Striped or multi-colored pads are not permitted.

Article 154. Logos:

- Logos may be worn but not exceed 200cm square (approx. 14cm x 14cm or equivalent). Club logos are permitted but must not exceed 200cm square at National competitions.

Article 155. Bridles and Bits:

1. Events run under National Rules at Introductory, Preliminary, Novice, and Elementary level – ordinary snaffle. See chart for full description of permitted bits, Appendix 1.
2. Events run under National Rules at Medium to Grand Prix level snaffle or double bridle. See chart for full description of permitted bits, Appendix 1
3. Nosebands are obligatory. See chart for full description of permitted nosebands, Appendix 2.
4. Bridles must be black or brown in color and reins must be attached directly to the bit.
5. Bit guards are not allowed.
6. A throat lash is required except when the combined noseband or Micklem bridle are used.
7. Events run under F.E.I. Competitions refer to current F.E.I. Rules.
8. Bridle numbers must be clearly displayed.

Article 156. Gadgets:

1. Martingales, breast plates, bit guards, any kind of gadgets (such as bearing, side, running or balancing reins, nasal strips etc.), and any form of blinkers, including ear plugs and any others, are, under penalty of elimination. This also applies to warming up prior to the competition.
2. Earplugs on Horses are forbidden but are allowed at Horse Inspections and Prize Giving Ceremonies only for safety reasons. Random checks will be conducted during the equipment check at the end of the test and contravening this rule will entail a Yellow Warning Card and Elimination.

Article 157. Decorations:

1. Any decoration of the Horse with extravagant items, such as ribbons or flowers, etc. is strictly forbidden.
2. A red ribbon in the tail, to indicate kicking is permitted.
3. Normal plaiting of the horse's mane and tail is allowed, using bands of the same color as the mane and tail.
4. Using glitter spray is permitted.

5. It is not allowed to paint any part of the Horses' body. It is strictly forbidden to use any type of substance (like "marshmallow fluff", shaving cream, etc.) around the Horses' mouth to imitate foaming; contravening the rule will entail a Yellow Warning Card and Elimination.
6. Fly masks are forbidden in the Competition arena but may be allowed in warmup and training arenas at the discretion of the Senior Judge or President of the GJ.

Article 158. False Tail/Tail Extensions:

1. False Tails / tail extensions are permitted.
2. False tails may not contain any metal parts (except for hooks and eyelets), or extra added weight.
3. Random checks will be conducted during the equipment check at the end of the test and contravening this rule will entail a Yellow Warning Card and Elimination.

Article 159 Ear Hoods:

1. Ear hoods are permitted for both indoor and outdoor venues and may also provide noise reduction.
2. The ear hoods should be discreet in color and should not cover the Horse's eyes and cannot be used for masking noise canceling earplugs.
3. Ear hoods may not be attached to the noseband.
4. If Ear Hoods are worn, they will be checked by the Steward and after being removed by the rider or groom.
5. Random checks will be conducted during the equipment check at the end of the test and contravening this rule will entail a Yellow Warning Card and Elimination.

Article 160. Checking of Saddlery:

1. A Steward must be appointed to check the saddlery of each Horse immediately after it leaves the arena. Any discrepancy will be reported to the Judge at C and result in immediate Elimination if confirmed.
2. The checking of the bridle must be done with the greatest caution, as some Horses are very touchy and sensitive about their mouths (see FEI Steward's Manual). The Steward must use disposable surgical/protective gloves when checking the bridle (a new pair of gloves must be used per Horse).

Article 161. Saddlery and bits in the warming-up and training arenas:

1. In addition to the above with regards to saddlery and bits, snaffles with a cavesson or a normal dropped noseband, Mexican noseband or a Flash noseband, boots, and bandages are allowed.
2. For F.E.I. Competitions refer to current F.E.I. Rules.
3. Single direct side reins or double sliding side reins (triangle) are permitted when lunging. Lunging is allowed with one (1) lunge line only.
4. Bridle numbers must be clearly displayed.

CHAPTER XI GRADING SYSTEM

Article 162. Grading Points:

Grading Points are awarded by achieving the following percentages:

60 – 61.99%	1 points
62 – 63.99%	2 points
64 – 65.99%	3 points
66 – 67.99%	4 points
68 – 69.99%	5 points
70 - 71.99%	6 points
72-73.99%	7 points
74 – 75.99%	8 points
76 - 77.99%	9 points
78 – 79.99%	10 points
80% & above	11 points

Points are not awarded for Intro or Music classes.

Article 163. Grading/Upgrading Horses:

1. Grading/Upgrading of horses will be decided by the following scale:
2. **Introductory level** – Open to both Unaffiliated and Affiliated Riders. When achieving three (3) 1st places with a Dressage score of 60% or above, the combination will automatically move up into Preliminary level. No points are awarded therefore allowing Centre/Club horses to stay at the same level to bring on more Novice riders.

	Seniors	Juniors
Preliminary	- up to 69 points	up to 69 points
Novice	- 70-129 points	70-129 points
Elementary	- 130-159 points	
Medium	- 160-274 points	
Advanced Medium	- 275-349 points	
Advanced	- open to any horse	

3. Horses competing in the FEI WDC will automatically be up-graded as follows:
 - a. FEI WDC Elementary upgraded to Novice
 - b. FEI WDC Medium upgraded to Elementary
 - c. FEI WDC Advanced up-graded to Medium
 - d. FEI WDC PSG upgraded to Advanced Medium

Article 164. Downgrading of Horses:

1. Upon registration, a horse maybe downgraded via the following options:

- a. Upon change of ownership or a rider, i.e., for the entirety of the season and restricted to that of the declared rider/owner at that level for the whole season maybe downgraded by a maximum of two levels lower than the horse's existing grading or to the highest competing level of the rider excluding Preliminary.
 - b. If a horse has not competed for one full season a horse may be downgraded by one level.
 - c. These exceptions are not accumulative.
 - d. To facilitate riders with horses on lease agreements, any horse leased on a ***“full season contract”*** (which can be proven and provided to the UAEERF) can be downgraded from the “owner/riders level” (within the directives of the downgrading rules above) but cannot change rider for the entirety of the season.
2. On expiration of the seasonal contract, in following season, once the owner/rider commences competing the horse again, the horse will resume competing at the original points.
 3. Please note: Regardless of cancelation of the lease (prior to the end of the contract) the horse concerned cannot compete with another rider for the remainder of that season.

Article 165. Grading on Import Horses:

At registration, proof of competitive results must be provided or documentation of non-competition from the exporting NF. Such horse will compete at its grading points, with the exception of the above article 164.

Article 166. Grading of Riders:

1. Riders who have competed at medium level and above shall not compete in preliminary classes.
2. However, should the same Rider have a young horse (4yrs old only) that they are bringing through, they will be permitted to ride Prelim on that young horse (4yrs) as HC.

CHAPTER XII SAFETY

Article 167. Horse out of control:

The judge may stop the performance, eliminate, deny rider or others to ride the horse on the show ground if it is a danger to the Rider, Horse, or other horses and people.

Article 168. Disobedience:

- During the test: If the horse is disobedient more than 20 sec continuously it will be eliminated by the Judge sitting at C
- During the warmup and the entire competition: Resistance that may endanger the Athlete, Horse, or others around will result in elimination for safety reasons. The Athlete will be asked by an Official to dismount and leave the arena.

Article 169. Dangerous situations:

When a horse/rider combination is experiencing extreme difficulty or is considered to be a danger to themselves or others, Competition Officials and/or GJ may, at its sole discretion and following extensive enquiries and consultation with owner/rider/trainer, direct that a particular course of action must be taken by the owner/rider. Such directions by **UAEERF** may include the following:

- a. Abstention** from competition and training to rectify the problems, or any other course of action, which in the opinion of **EEF** might resolve the situation.
- b.** Club Managers are required to carefully monitor the competence/suitability of their riders/horses.

CHAPTER XIII PROTECTION OF ATHLETES AND HORSES

Article 170. Protection of Athletes:

1. Whenever mounted on the show grounds the use of a properly fastened Protective Headgear will be mandatory. In the Competition arena and adjacent warm-up areas, as well as riding from one to the other and from the stables for the purposes of competing, the Protective Headgear requirements are governed by Art. 145.
2. Failure to wear such Protective Headgear as and when required after being notified to do so by a Competition Official, shall result in a Written warning being issued to the Athlete unless exceptional circumstances apply.
3. The Ground Jury after consultation with the responsible medical officer may at any time exclude from further participation in a Competition or an entire Event any Athlete who is unfit to continue by reason of a serious or potentially serious injury, impairment, or health condition.
4. A Certificate First Aid person needs to be presented at the entire show.

Article 171. Protection of Horses:

In cases of illness or injury during an Event, the Ground Jury will decide, after consulting the Veterinary Delegate or Commission, whether the Horse may continue in that or subsequent Competitions.

Article 172 - Abuse of Horses:

1. No person may abuse a Horse during an Event or at any other time. "Abuse" means an action or omission which causes or is likely to cause pain or unnecessary discomfort to a Horse, including, but not limited to:
 - a. - To whip or beat a Horse excessively.
 - b. - To subject a Horse to any kind of electric shock device.
 - c. - To use spurs excessively or persistently.
 - d. - To jab the Horse in the mouth with the bit or any other device.
 - e. - To compete using an exhausted, lame, or injured Horse.
 - f. - To "rap" a Horse.

- g. - To abnormally sensitize or desensitize any part of a Horse.
 - h. - To leave a Horse without adequate food, drink, or exercise.
2. Any person witnessing an Abuse must report it in the form of a protest without delay. If an Abuse is witnessed during or in direct connection with an Event, it should be reported as a protest to an Official. If the Abuse is witnessed at any other time, it should be reported as a protest to the Secretary General for referral to the **UAEERF** Dressage Committee.

Article 173. Medication Control and Anti-Doping:

1. Medication Control and Anti-Doping provisions are stated in the Anti-Doping Rules for Human Athletes (ADRHA), in conjunction with The World Anti-Doping Code, and in the Equine Anti-Doping and Controlled Medication Regulations (EADCM Regulations).
2. The decision as to whether a Horse may compete in an Event when under treatment or medication with a Prohibited Substance is made by the President of the Ground Jury on the recommendation of the Veterinary Delegate or Commission according to the procedures set out in the Veterinary Regulations.
3. It is forbidden for any rider or horse to take part in any competition whilst under the influence of any drug, stimulant, sedative or any banned substance included on the **F.E.I.**, **I.O.C.**, or **U.A.E.** Olympic Council's list of prohibited substances. Appropriate tests may be taken at any time by a medical or veterinary practitioner authorized by either **U.A.E.** Olympic Council, the **F.E.I.**, the **I.O.C.**, or **UAEERF**.
4. Infringement of this rule may incur the maximum penalty of disqualification and expulsion for life from **NF**.
5. Random Medication Control Programme (**MCP**) will be conducted by **F.E.I./NF**, throughout the season. Refer to procedures as per the current **F.E.I.** Dressage Rule Article 444 – refer to current **F.E.I.** General Rules, the **F.E.I.** Veterinary Regulations, the Equine Anti-Doping and Controlled Medication Regulations and any other applicable **F.E.I.** Rules and Regulations.

Article 174. Veterinary Examination:

1. Horses attending a show and/or entered for competitions may be required by the Official Representative of **NF**, **UAEERF** Veterinary Surgeon and/or the Senior Judge (for National Events) or the President of the Ground Jury (for International Events) to undergo a veterinary examination (including blood/urine sampling and/or swabbing) before being allowed to compete or subsequent to competition.
2. Examination of Boots/Bandages/Saddlery etc. used in the Warm-up area may be conducted prior to competition at the discretion of the Official Representative of **NF**, **NF** Veterinary Surgeon and/or the Senior Judge (for National Events) and/or the President of the Ground Jury (for International Events). The decision made by acting Officials following such an examination will be final and binding

CHAPTER XIV JUDGES AND OFFICIALS

Article 175. Mission:

1. The Mission of all Federation Officials is to promote, guide, develop and manage Equestrianism throughout The United Arab Emirates in the aspects delegated to them, from time to time, by the NF.
2. The principal obligations include:
 - a. To act with integrity in all matters.
 - b. To represent NF effectively, loyally, diligently, and impartially.
 - c. Common mission.
 - d. To monitor Equestrianism worldwide in order that they and NF remain up to date with International developments.

Article 176. Conflict of Interest:

1. A substantial appearance of a conflict of interest exists whenever an individual involved in any capacity with the NF is involved in or perceived to be involved in multiple interests, one of which could possibly corrupt, or is perceived to corrupt, the motivation for an act in the other.
2. A conflict of interest is defined as any personal, professional or financial relationship, including relationships of family members that could influence or be perceived to influence objectivity when representing or conducting business or other dealings for or on behalf of the NF.
3. Conflicts must be avoided whenever practicable. However, conflicts may be linked to experience and expertise that is necessary to qualify Officials. The specific balance between conflict and expertise shall be regulated by the relevant Sport Rules.

Article 177. Reports:

1. Officials (Senior Judge and Chief Steward) are required to send Reports to the UAEERF at the conclusion of Events, in accordance with these Rules. Matters giving rise to Protests must be included in such reports. Reports must be submitted within 7 business days.
2. Failure to return Report(s) to the NF shall be sanctioned by the NF, first with a warning and then by a Suspension until the outstanding Report(s) has been provided to the NF.

Article 178. Federation Officials Code of Conduct A:

1. Be fully conversant with all the Rules and Regulations relative to their assigned duties.
2. Attend to their assigned duties on time and fully prepared.
3. Dress in the proper way or formally, as appropriate for weather conditions.

Article 179. Federation Officials Code of Conduct B:

1. Be absent or late for duty without permission.
2. Conduct himself in a manner which might bring the Country, the Sport or NF into disrepute.

Article 180. Judges:

1. Judges and Officials will always be subject to their Code of Practice, together with all the Rules, Regulations and Instructions of NF.
2. Judging will be conducted through the medium of English.

3. The United Arab Emirates Equestrian and Racing Federation shall appoint a panel of persons to act as Judges for Dressage Competitions from a list recommended by **NF**. Judges shall be appointed at the sole discretion of **NF** upon recommendation and with such qualifications as the Federation shall in each case require.
4. UAEERF shall publish each year a list of the persons authorized.
5. UAEERF may, from time to time, recommend to **F.E.I.**, persons deemed suitable (by UAEERF) to undertake technical courses for the qualification of Judges, Stewards and Veterinary Surgeons in the various categories as decided by the **F.E.I.** Such **F.E.I.** qualifications for such personnel are always subject to annual review and endorsement or otherwise, by both **F.E.I.** And **NF**.
6. Both **NF** and **F.E.I.** (either collectively or separately) reserve the right to remove or demote any person from any list that should be deemed correct. Removal or demotion from the list will be supported by a full explanation. Actions which could contribute to the removal/demotion will be clearly communicated.
7. Permission from **NF** will be required if there is a clear conflict of interest between the local duties of the official and the said International Event. Any persons on the **NF** list, should notify the **NF** of their participation in such events.

Article 181. Official Representative at an Event:

1. The Official **NF** Representative will be the Senior Official at all Events.
2. The Ground Jury should consist of the dressage judges at the event, the most senior UAE dressage judge will also be President of the Ground Jury.

Article 182. Senior Judge/Ground Jury – Duties:

1. Senior Judge (SJ)/Ground Jury (GJ) shall instruct the Organizer, as appropriate, to make any alterations to matters which come under his jurisdiction, which he considers necessary.
2. If there is no Technical Delegate, the President of the Ground Jury or the Senior Judge retains direct responsibility.
3. The SJ/GJ shall be competent to deal with all Protests within the meaning of this Rules relate to matters anything occurring during or in direct connection with an Event and that they are presented within the period of its jurisdiction within the meaning of this Rules.
4. The period of jurisdiction of the SJ/GJ commences one (1) hour before the beginning of the first Horse inspection and terminates half an hour after the announcement of the final results in the relevant Event.
5. In appropriate cases involving veterinary matters during Events for which there is no and in the absence of an Appeal Committee, the President of the Veterinary Commission or the Veterinary Delegate at an Event must be/are invited to join the Ground Jury in an advisory capacity.
6. The SJ/GJ may impose the following penalties and sanctions on Officials, Owners of Horses, Persons Responsible, Athletes and team officials:
 - a. An oral Warning
 - b. A written warning
 - c. Elimination and/or Disqualification of an Athlete(s) and/or one (1) or more Horse(s) from Competition(s) and/or from an Event
 - d. In serious cases, immediate Disqualification during the Event with a referral to the Appeal Committee (or to the **NF** if there is no Appeal Committee).

7. Decisions must be made in writing to the parties concerned. Cases involving penalties must be recorded by the SJ/GJ.
8. There is no Appeal against Decisions of the SJ/GJ which are final and binding in the following cases:
 - a. Where the question for Decision is based on a factual observation of performance during a Competition or the awarding of marks for performance; Examples of issues that are finally decided by the SJ/GJ (which are not exhaustive): The Judges marks, whether a Horse was disobedient, whether the particular track followed by an Athlete has caused him to incur a penalty.
 - b. The Elimination or Disqualification of a Horse for veterinary reasons, including non-acceptance of a Horse at a Horse Inspection.
 - c. The Elimination or Disqualification of an Athlete for medical reasons.
 - d. The imposition of a Warning without additional penalties.
 - e. Immediate Elimination and/or disqualification in an Event.
9. The Ground Jury shall refer the following to the Appeal Committee/NF:
 - a. Any case matter which is beyond its competence.
 - b. Any case matter, within its competence which it considers deserving of more severe penalties than the SJ/GJ may impose under Article 164.4.
 - c. Any matter concerning alleged acts of abuse of Horses that does not require immediate action, the Decision of which is not immediately required for the purpose of judging a Competition and which, having regard to its primary duty to judge the Competition, it deems more appropriate to be dealt with by the Appeal Committee/NF

Article 183. Stewards:

1. NF may appoint a Chief Steward for an event, who will act subject to the President of the Ground Jury (National Championships or International Events) or Senior Judge (National Competitions) and as such will be in charge of the collecting ring, exercise arena, stabling area and other locations thought necessary and who will report any transgressions of NF Rules to the President of the Ground Jury or Senior Judge.
2. OCs of all National Events must appoint a Chief Steward and an appropriate number of Stewards under the authority of the Chief Steward, wearing distinctive identification such as badges, arm bands, bibs, etc., with complete freedom of access to all areas mentioned in Article 183.5 below.
3. OCs are responsible for all administrative matters relating to the Appointment of the Chief Steward and the Stewards, unless Steward is appointed by NF.
4. During the whole Event in every part of the stables, in exercise and schooling areas, collecting rings and all other areas under control of the OC. The Chief Steward and the Stewards officiating with him/her at the Event shall:
 - a. Assists the Athletes in conducting reasonable training.
 - b. Intervenes in time to prevent any abuse of Horse by Athletes, grooms, owners or any other person.
 - c. Intervenes to prevent any contravention of this Rules or of the common principles of behavior, fairness and accepted standards of sportsmanship.

- d.* Be familiar with and assist with doping and medication control procedures.
5. One Steward must be on duty at the collecting ring whenever it is in use.
6. Any irregularities must be reported immediately by the Chief Steward to the SJ/President of the Ground Jury.
7. The Chief Steward is required to send a report to the Secretary General on the stewarding of the Event as a whole and on any incident which occurs during that Event. A copy of the report must be given to the SJ/GJ, to NF and to the OC of the Event.
8. The Chief Steward must be a person experienced in equestrian sports, particularly in the Discipline of the Event where he is appointed to officiate.
9. The name of the appointed Chief Steward must be published in the schedule and in the programme of the Event.
10. NF maintains a list of all qualified Stewards. The Chief Stewards must be selected from this list.

CHAPTER XV THE LEGAL SYSTEM

Article 184. Preamble:

The Legal System provides for the following:

- The legal powers and responsibilities of UAEERF, Officials, and bodies appointed under these Rules.
- A scale of penalties.
- A procedure for lodging protests and reports against the actions or behavior of individuals or bodies under the jurisdiction of NF.
- A process of Appeal to a higher body against Decisions taken or penalties imposed by any person or body acting under these Rules.
- Before reaching a Decision on any protest or Appeal, the relevant body must examine the available evidence, whether written or oral, hear all the parties concerned (provided they are available) and consider all relevant material, in every case trying to reach a fair and equitable Decision.

Article 185. Federation Powers:

1. NF shall be empowered to direct the Organizers to refuse any entry with stating reasons; it shall be the sole judge of the qualification of any horse or rider to compete in any class/event and may, at its discretion, refuse the entry or transfer the entry of any such horse or rider to a lower or higher-ranking class.
2. NF may, from time to time and its sole discretion, have the power to delegate such duties, responsibilities and authority as it deems fit, to any individual committee or sub-committee and thus authorize such groups to act with authority on its behalf.

Article 186. Penalties:

1. In deciding on the appropriate penalties to be imposed, the following factors shall be taken into consideration, together with any other relevant factors:
 - a. Whether the action or omission resulted in an unfair advantage to the offender or an Athlete.

- b. Whether the action or omission resulted in a material disadvantage to any other person or body involved.
 - c. Whether the action or omission involved the maltreatment of Horse(s).
 - d. Whether the action or omission affected the dignity or integrity of any person involved in the sport.
 - e. Whether the action or omission involved fraud, violence or abuse or similar criminal acts.
 - f. Whether the action or omission was deemed to be deliberate.
2. An oral or written warning is appropriate in cases of minor violations or contraventions committed unintentionally and without significant consequences.
 3. Disqualification is appropriate when it is specified in the Rules, or if the circumstances require immediate action.
 - a. Disqualification from a Competition means that the Athlete and Horse or Horses concerned - even should they change ownership - are removed from the list of starters and the classification and includes the forfeiture of prize money won in that particular Competition.
 - b. Disqualification from an Event means that the Athlete and Horse(s) concerned - even should they change ownership - may take no further part in that Event and it may include the forfeiture of any prize money won in previous Competitions at that Event where this is provided for in this Rules.
 4. A Provisional or Final Suspension, on such terms and subject to conditions as **NF**, may impose, is appropriate in cases of intentional or very negligent violations or contravention. In certain cases, a Provisional or Final Suspension may be automatic under Rules:
 - a. Suspension must be for a stated period and during that period the person, Horse or body suspended may take no part in Competitions or Events as an Athlete, Horse or Official or in the organization of, or participation in, any Event under the jurisdiction of the **FEI** or any Event under the jurisdiction of **NF**.
 - b. In deciding when any Suspension will commence, the appropriate body shall, in order to achieve a just penalty, have regard to the gravity of the offence.
 - c. Abuse of Horse(s) in any form (rapping, abnormal sensitization or desensitization of limbs, banned schooling methods etc.) shall entail a Suspension of a minimum of three (3) months up to life.
 - d. Incorrect behavior towards Event Officials or any other party connected with the Event (other Athlete, journalist, public etc.) shall entail a Suspension of a minimum of three (3) months up to twelve (12) months.
 - e. Fraud of any kind, violence and other acts defined as criminal by the national law prevailing at the Event shall entail a Suspension of a minimum of one (1) month up to life.
 5. In cases of offences mentioned in paragraphs 4.c and 4.d above and which are of a less serious nature and/or in cases specified in the Sport Rules and/or as mentioned in Article 186:
 - a. The SJ/President of the Ground Jury, the President of the Appeal Committee and the Chief Steward may deliver to the Person Responsible a Written Warning, either by hand or by any other suitable means.

- b. Should the same Person Responsible receive one (1) more Written Warning at the same or any other International Event within one year of the delivery of the first Written Warning, the Person Responsible shall be automatically suspended for a period of two (2) months from the day following the Event at which the Person Responsible is competing after official notification from **NF** shall be responsible to notify the Person Responsible of such suspension.
6. The penalty imposed in any given case can consist of a combination of Suspensions and disqualification. The duration of a Suspension shall be decided according to the guidelines mentioned in Article 186.4 above and to the circumstances of the case.

CHAPTER XVI OBJECTIONS

Article 187. Submission of Objections:

1. For an objection to be valid it must be in writing, addressed to the President of the Ground Jury for **F.E.I.** International Competitions or the Senior Judge for National Competitions. Refer to current **F.E.I.** General Rules for a full explanation for **F.E.I.** International Dressage Competitions.
2. The objection should be accompanied by a deposit of 200 AED and lodged with the President of the Ground Jury. Such a deposit will be refunded if the objection is considered to be valid, otherwise **NF** will retain it. The written objection should include the fullest details, including the Article Number/s allegedly offended. Written/signed/dated reports from witnesses and dated photographs and/or videos may be included.
3. An objection does not include a query made to the **F.E.I.** Ground Jury at International Competitions or Senior Judge at National Competitions or other official of the event, before the commencement of a competition.
4. An objection may only be made by:
 - a. An adult owner or registered Rider, who is involved in the competition, or their respective duly authorized agent, or the duly authorized guardian of a minor, competing in the competition.
 - b. The Chef d'Equipe.
 - c. **NF** Representative or an Official of the event.

Article 188. Time Limit:

1. The objection must be lodged within the following time limits:
 - a. Concerning the eligibility of any rider or horse – not less than 30mins before the commencement of the class.
 - b. Concerning the arena, plan or anything related to the way the competition is being conducted not less than 30 minutes before the commencement of the competition.
 - c. Concerning any incident or decision arising during the competition not later than 30 minutes after the announcement of the results.

Article 189. Referral to Federation:

The foregoing shall not prevent any matter being drawn to the attention of **NF** for any actions **NF** may deem appropriate. However, reports lodged with the Secretary General 10 days after the event will not be considered.

Article 190. Query:

Any rider, or agent, who has a query, rather than an objection, at any time during the show, must, for it to be valid, make it in writing, address it to the President of the Ground Jury and lodge it with **NF** Steward. No deposit is required with a query.

Article 191. Appeal:

1. An appeal may be made against the Senior Judge at National Competitions on an objection lodged.
2. For such an appeal to be legal it must be made in writing, lodged with the UAEERF Dressage Committee within one (1) hour of the previous decision of the Senior Judge at National competitions.
3. If an appeal is lodged, The UAEERF Dressage Committee may deal with the matter directly, or if they deem it necessary, call upon two suitable persons to form an Appeal Committee. The decision of the Appeal Committee is final.

Appendix 1 – Permitted Bridles/Bits

Saddles

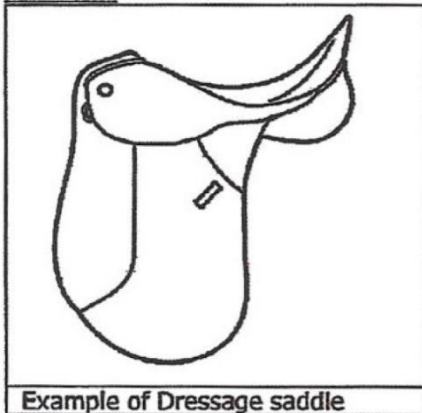

Bridles

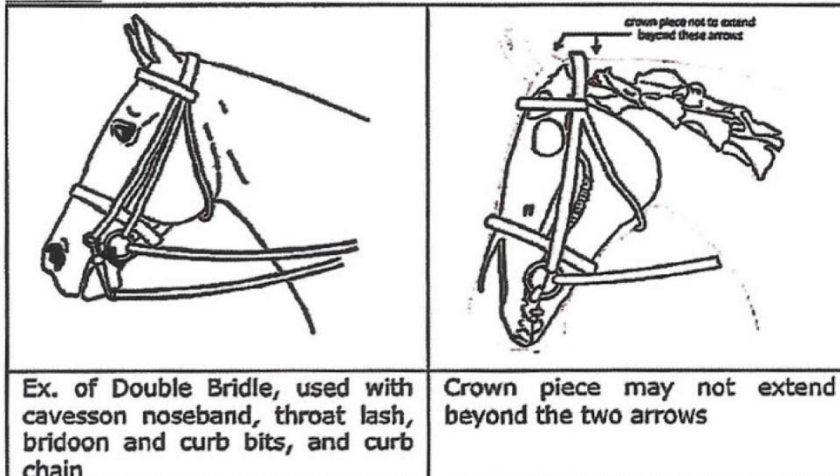

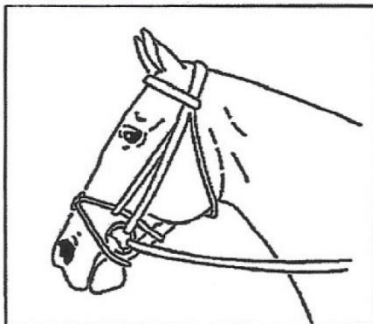
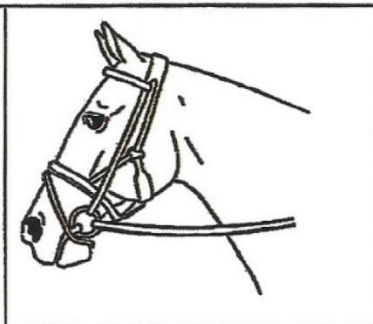
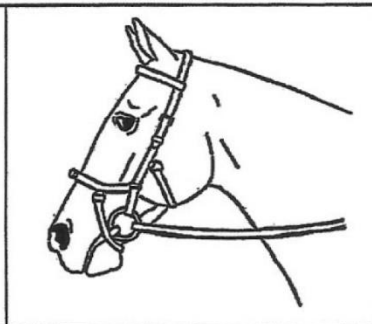
		
Ex. of crossed/mexican/grackle noseband	Ex. of combined noseband – no throat lash necessary	Ex. of Micklem style bridle – no throatlash necessary

Bits



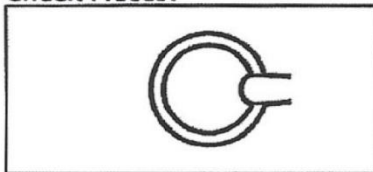
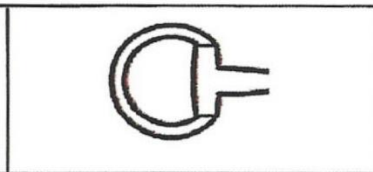
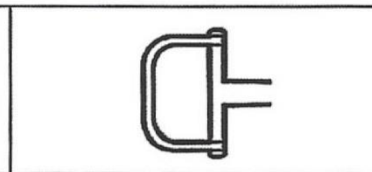
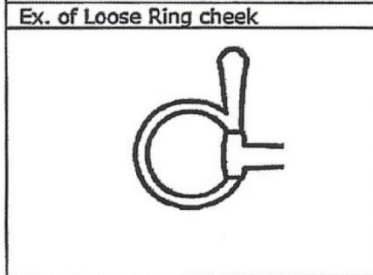
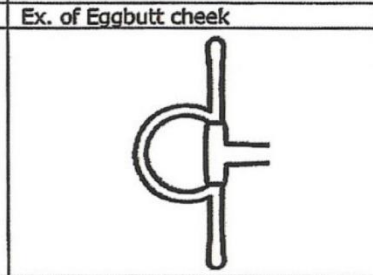
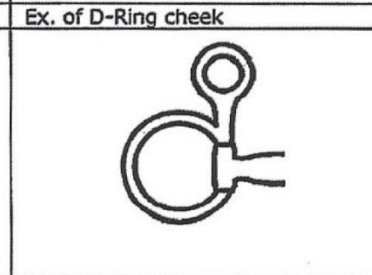
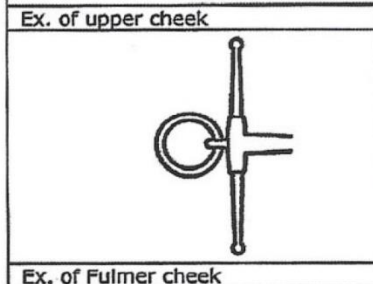

Cheek Pieces:

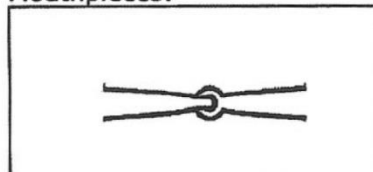
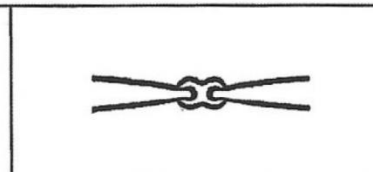
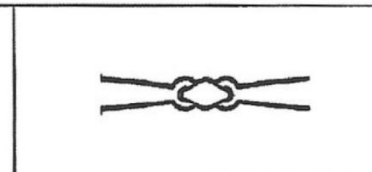
		
Ex. of Loose Ring cheek	Ex. of Eggbutt cheek	Ex. of D-Ring cheek
		
Ex. of upper cheek	Ex. of full cheek	Ex. of hanging cheek
		
Ex. of Fulmer cheek		

Mouthpieces:

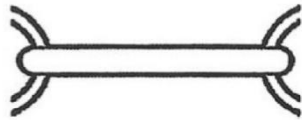
		
Ex. of single jointed mouthpiece	Ex. of double jointed mouthpiece	Ex. of double jointed mouthpiece

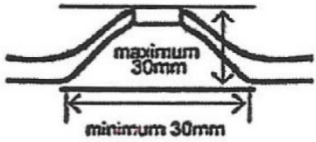

Appendix 2 - Arenas

		
Ex. of unjointed mouthpiece	Ex. of barrel joint	Ex. of ball joint
		
Ex. of double ball joint	Ex. of centrepiece with a roller	Port deviation measurements

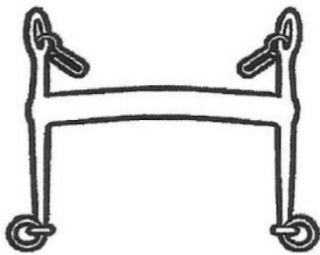
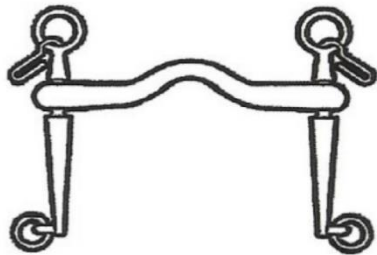
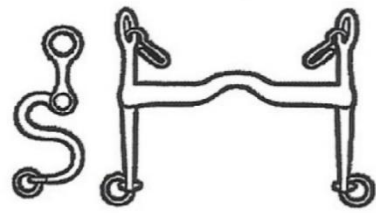
Curb Bits:

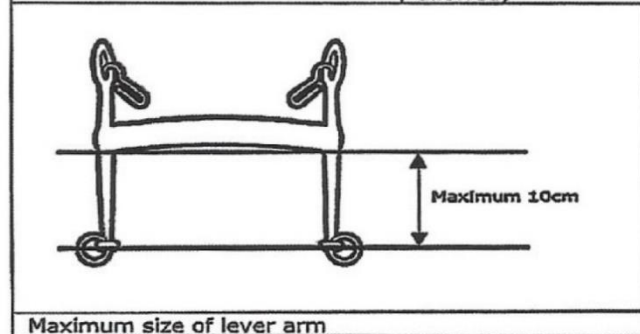
		
Ex. of curb with straight cheeks	Ex. of curb with port and sliding mouthpiece (rotating arms also allowed)	Ex. of curb with S cheeks

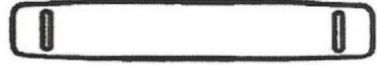

	
Ex. of Curb chain	Ex. of Leather cover for curb chain
	
Ex. of lip strap	Ex. of cover for curb chain

20 x 40 meter Arena

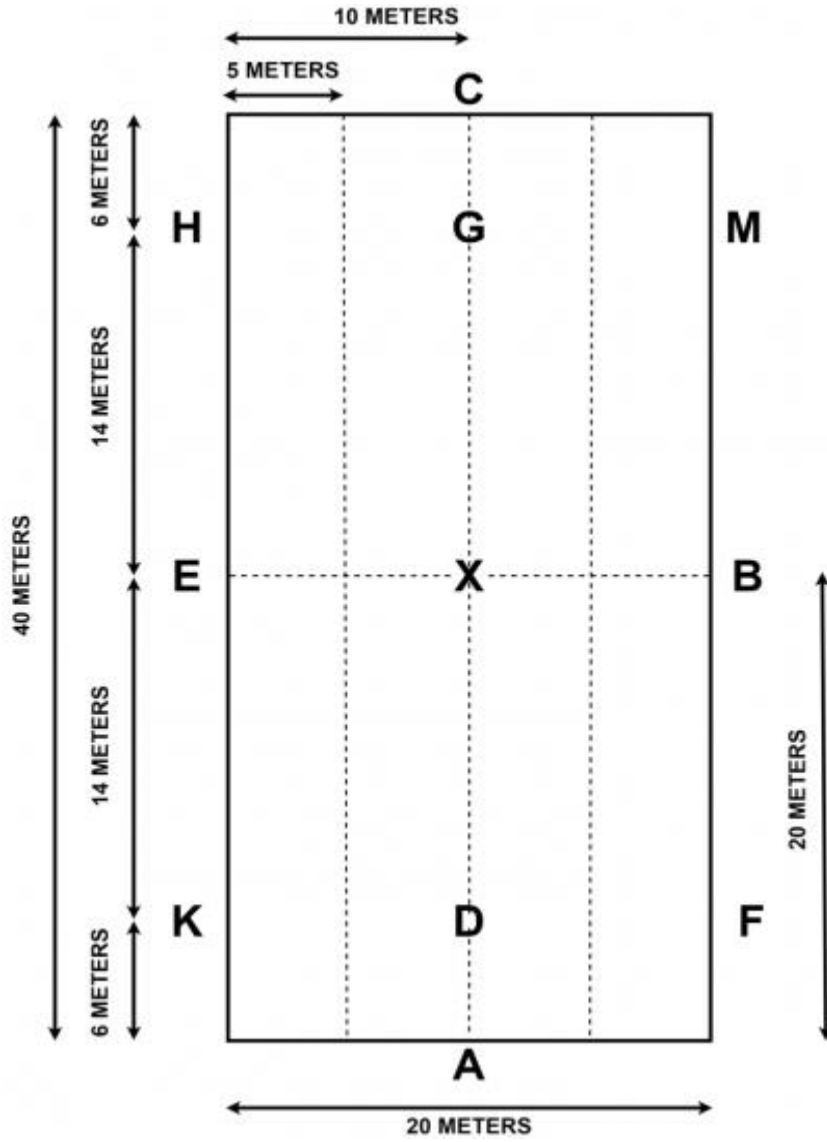

20 x 60 meter Arena

